

MBE-AFP – active frost protection

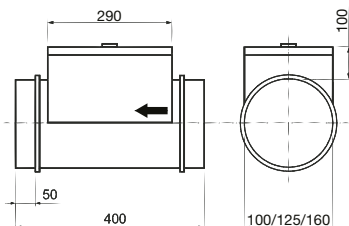

Notice

When the ventilation system is turned off, the fan must be allowed to run for cooling down the heating rods with a delay of min. 2 minutes. Otherwise, there is a risk of damage to the heater and other equipment.

Technical parameters

Housing

- is standardly made of galvanized sheet metal without insulation
- the housing contains a terminal block and an electronic control unit with two temperature sensors
- designed for EHR 140, 280, 300, 325 and 480 units, DOMEO 210, IDEO 325, 450 and others
- heating rods are made of stainless steel
- equipped with a safety grid at the entrance and exit

Electrical connection

- 2 thermostats, operating thermostat 45°C and safety thermostat 70°C, non-returnable safety fuse 110°C
- NTC temperature sensor to set the working value according to the input temperature, adjustable with an internal potentiometer 0–20°C
- NTC temperature sensor to set the output temperature, adjustable with an internal potentiometer 0–30°C

- the safety thermostat button is accessible inside the terminal box, it can be placed on the cabinet lid if desired
- the heater must be located in such a way that free access for service and maintenance is ensured
- IP42 protection

Regulation

- the controller is powered directly from the 230VAC/50Hz distribution network
- the output temperature is continuously controlled 0–100%, it can be set internally with a potentiometer 0–30°C
- the controller allows the connection of an external channel sensor (electrical insulation class II.), which detects the current air temperature behind the heater or recuperator
- it is possible to block the heater when the inlet temperature reaches the set value of 0–20°C
- it is possible to block the heater by connecting an external air flow sensor, pressure sensor, room thermostat, etc.

Accessories

- TGCU-3-IZ – external output for temperature sensor – electrical insulation class II.

Important

Before and after the heater, it is necessary to install min. 0.5 m of steel pipe to avoid contact with flammable parts. It is necessary to use an air flow sensor or a pressure sensor to block the operation of the heater when the flow drops, or flow rates below the permitted limit.

Information

The MBE AFP heater can be used very simply to reheat the incoming fresh air. If the setting of the output temperature with the internal potentiometer is not sufficient, it is possible to use a room wall thermostat with an opening contact, which blocks the operation of the heater when the room temperature is reached. Conversely, when the room temperature drops, the thermostat unlocks the operation of the heater.

Characteristics

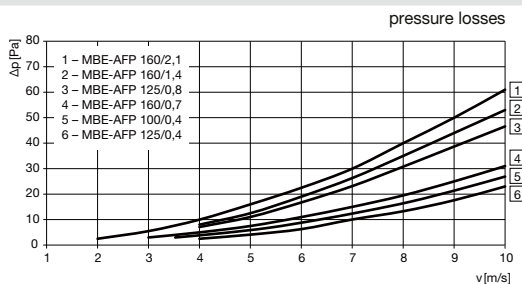
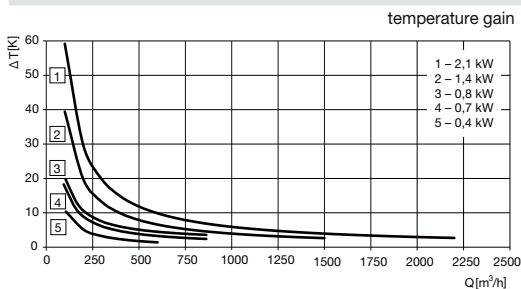

Type	input power [W]	voltage [V]	current [A]	fusing [A]	piping [mm]	min. flow [m³/h]
MBE-AFP 100/0,4	400	1/230	1,70	2	100	40
MBE-AFP 125/0,4	400	1/230	1,70	2	125	58
MBE-AFP 125/0,8	800	1/230	3,48	4	125	60
MBE-AFP 160/0,7	700	1/230	3,04	4	160	63
MBE-AFP 160/1,4	1400	1/230	6,08	10	160	76
MBE-AFP 160/2,1	2100	1/230	9,13	10	160	95

MBE-AFP – active frost protection

Supplementary image

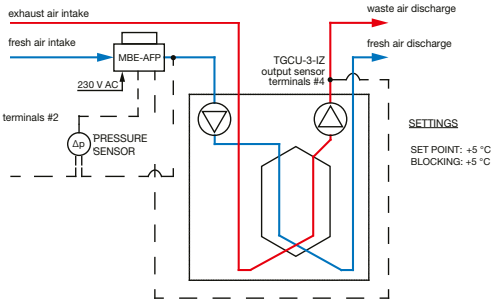

technological circuit diagram of the electric heater in preheating mode (anti-freeze protection of the unit) using an external NTC temperature sensor ($T_{s} \geq 5^{\circ}\text{C}$ set value SET POINT, $T_{s} \geq 5^{\circ}\text{C}$ set value BLOCKING)

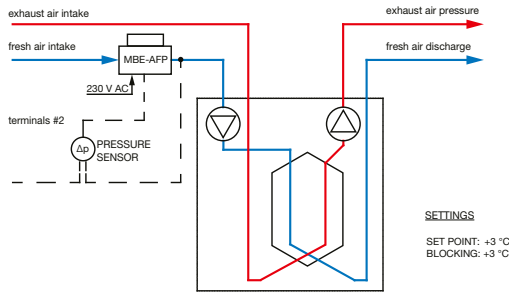

technological diagram of the connection of the electric heater in the preheating mode (anti-freeze protection of the unit) without the use of an external NTC temperature sensor ($T_{s} \geq 3^{\circ}\text{C}$ set value SET POINT, $T_{s} \geq 3^{\circ}\text{C}$ set value BLOCKING)

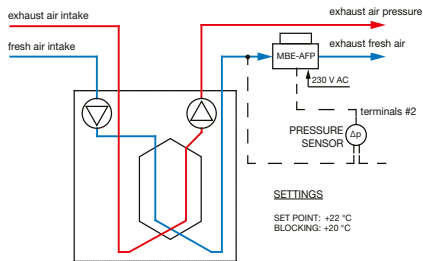

technological diagram of the connection of the electric heater in the mode of supply air reheating ($T_{s} \geq 22^{\circ}\text{C}$ set value TGCU-3-IZ SET POINT sensor, $T_{s} \geq 20^{\circ}\text{C}$ set value BLOCKING)

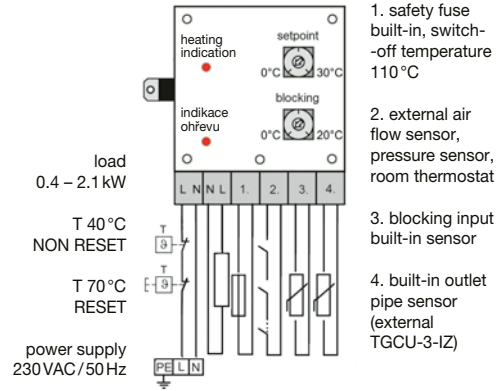

wiring diagram

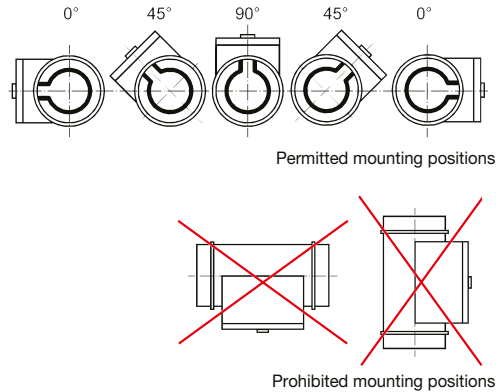

When installing MBE-AFP, it is necessary to install a DTS PSA 20/200 pressure sensor in the pipe. In the case when MBE-AFP is installed as a preheater, we recommend adding a TGCU-3-IZ temperature sensor